

801 Series Solar Mega Snake® 12" Wide 30° Turn

Center Support Rail

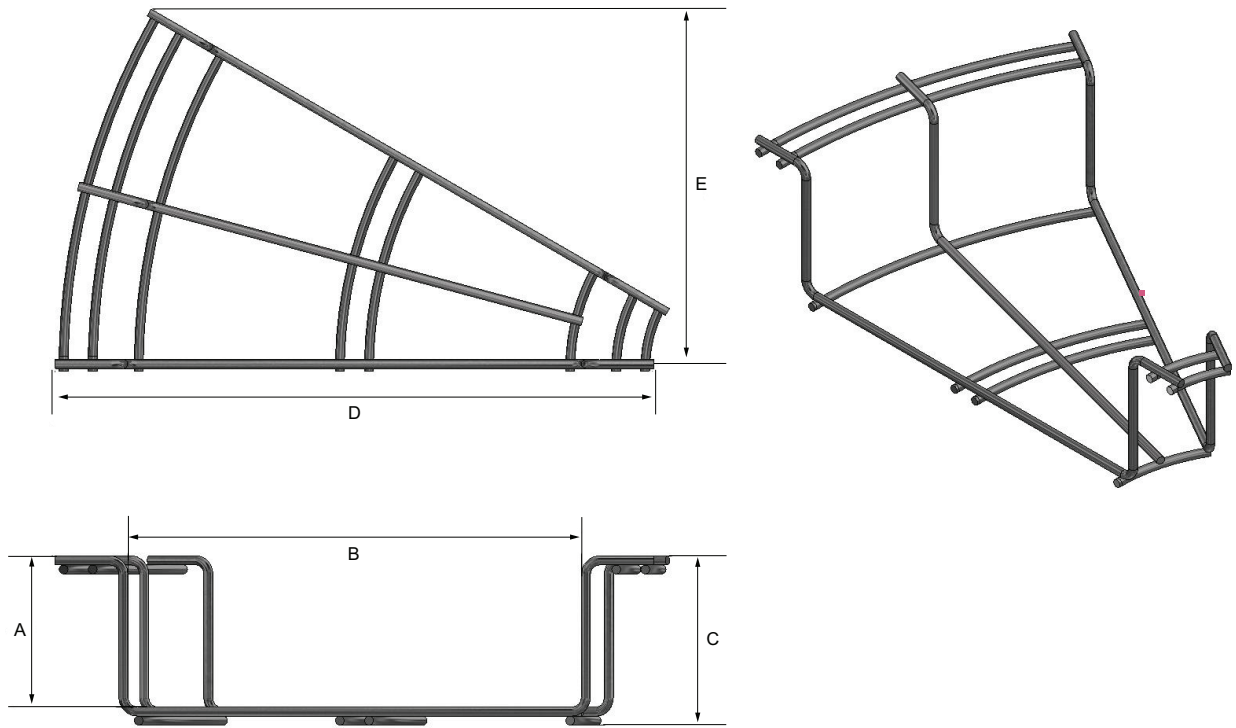

Part Number	Loading Dimensions		Cable Capacity		Physical Dimensions			Finish
	Depth (A)	Width (B)	Area	# of Cables (CAT6)	Height (C)	Width (D)	Width (E)	
CM 801-2-12-30	2"	12"	24 si	250	2.50"	16"	9.73"	SS/PC
CM 801-4-12-30	4"	12"	48 si	490	4.50"	16"	9.73"	SS/PC
CM 801-6-12-30	6"	12"	72 si	735	6.50"	16"	9.73"	SS/PC

THESE PRODUCTS ARE MANUFACTURED WITH CENTER SUPPORT RAIL FOR CENTER HANGING OPTIONS.

CABLE CAPACITY BASED ON 50% FILL AS PER NEC ARTICLE 392.9B 0.25 OD
 FINISHES: STAINLESS STEEL (SS), POWDER COATED (PC)

The 801 Series Mega Snake® is pre-manufactured in straights, turns, tees and crossing sections so no material waste is created. This system has an accessory rail that allows the tray to be mounted without the need for under support. It also provides a place to mount equipment such as patch panels and electrical boxes. The 801 Series Mega Snake® is a UL Classified Equipment Grounding Conductor (EGC).

For drawings of specific models, additional sizes or accessories please call us at 800.308.6788



Snake Tray® products are covered by one or more of the following patents: #6637704, #6637165, #6463704, #6460812, #6449912, #6361000, #6347493, #6019323, #6347493, #6449912, #6460812, #5953870, #5839702, #6926236, #7168212, #7959019, #8783628, #8985530, #8622679, #9074707, #10944355, #10666029, #11205890 B2, #11271519. Foreign Patents: Australia #737813, #748160, #749488, #776643, #776644. Canada #2251732, #2319624, #2303081, #2396792. Japan #3723224. Mexico #204995, #229386, #220889. Europe #1012938, 1012937. Other Patents Pending.

SNAKE TRAY®

CABLE MANAGEMENT, POWER DISTRIBUTION AND ENCLOSURES

291 SKIP LANE, BAY SHORE, NEW YORK 11706 USA | TEL: 800-308-6788 | 631-674-0004

Document No. MKTG-0259 | Revised October 2022 | © 2022 Snake Tray

Made in the USA