

DWG NO:		CM 0606				
REVISION						
ZONE	REV	DESCRIPTION	ECN	DATE	APPROVED	ENGINEER
	A	INITIAL RELEASE	10-0000	3/23/2010	RJ	WW

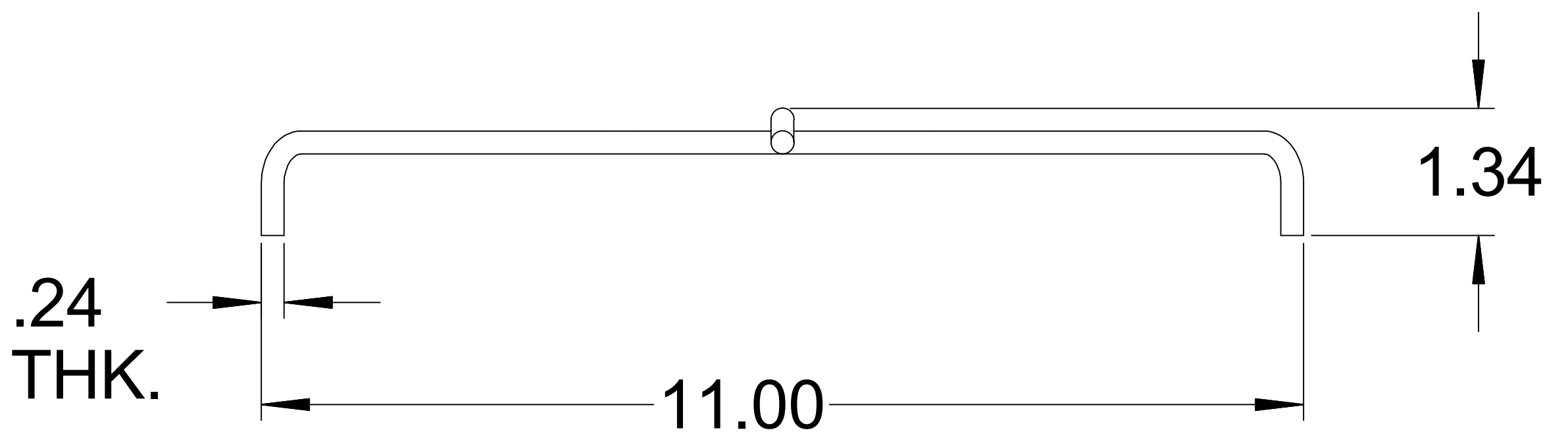
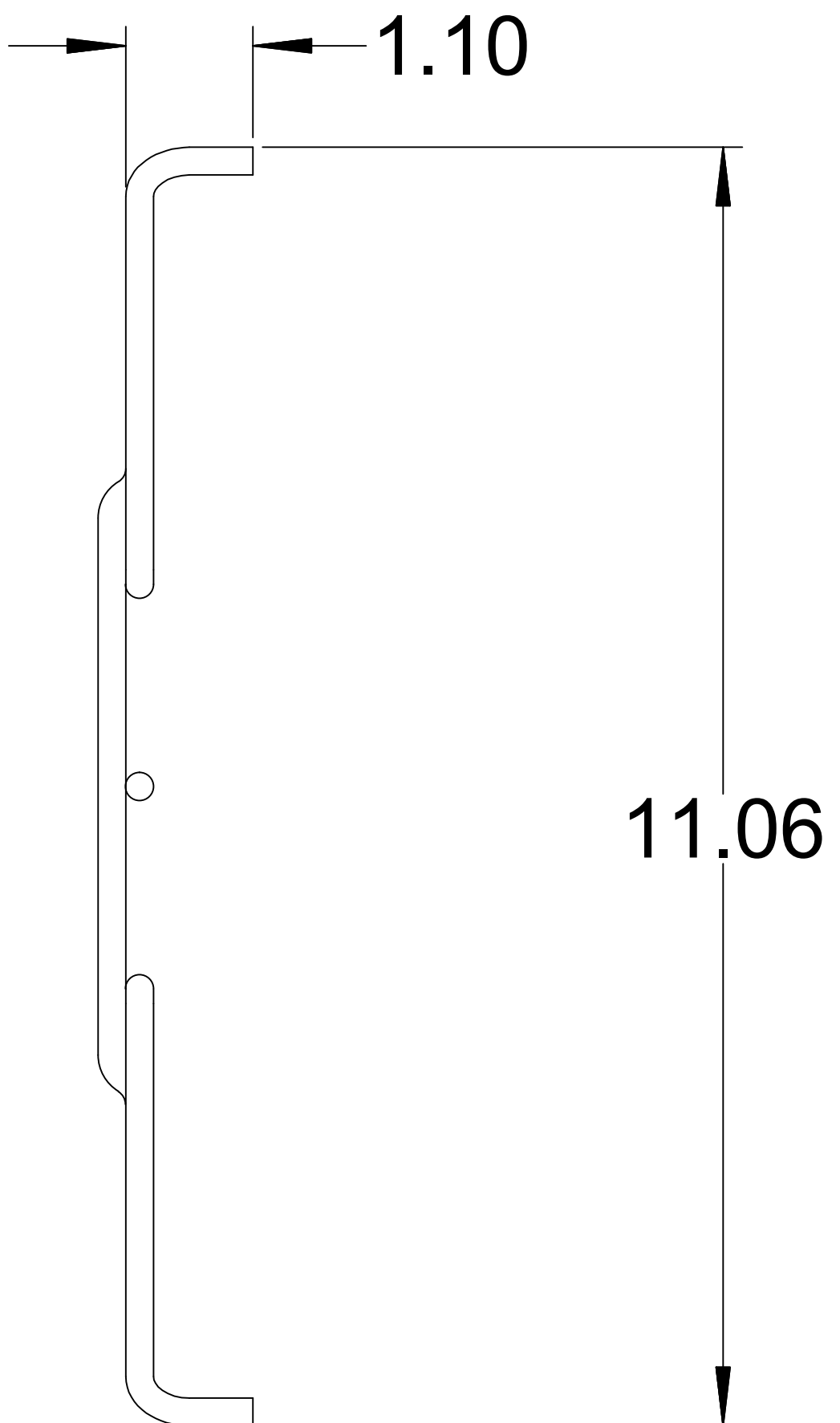
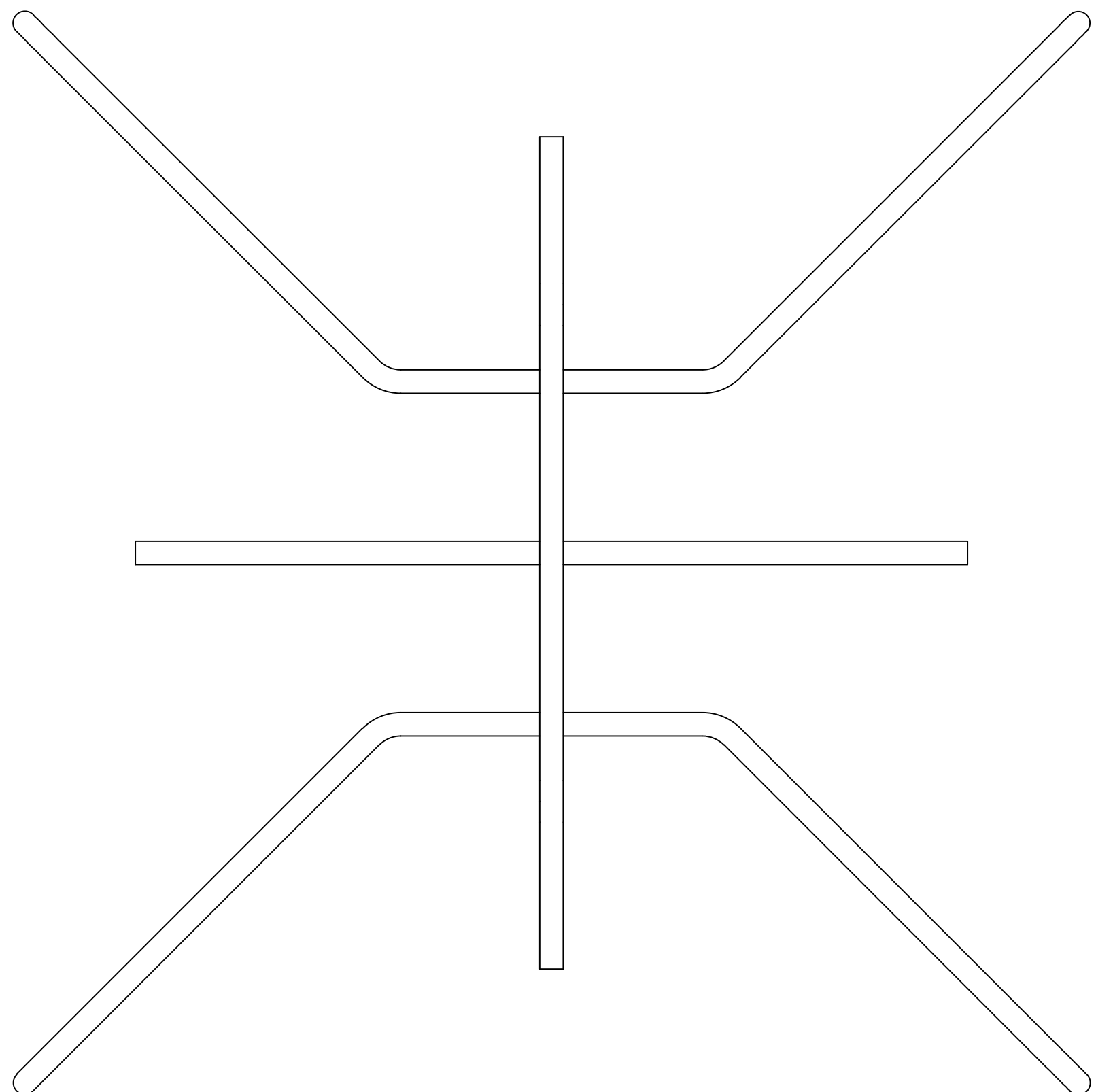
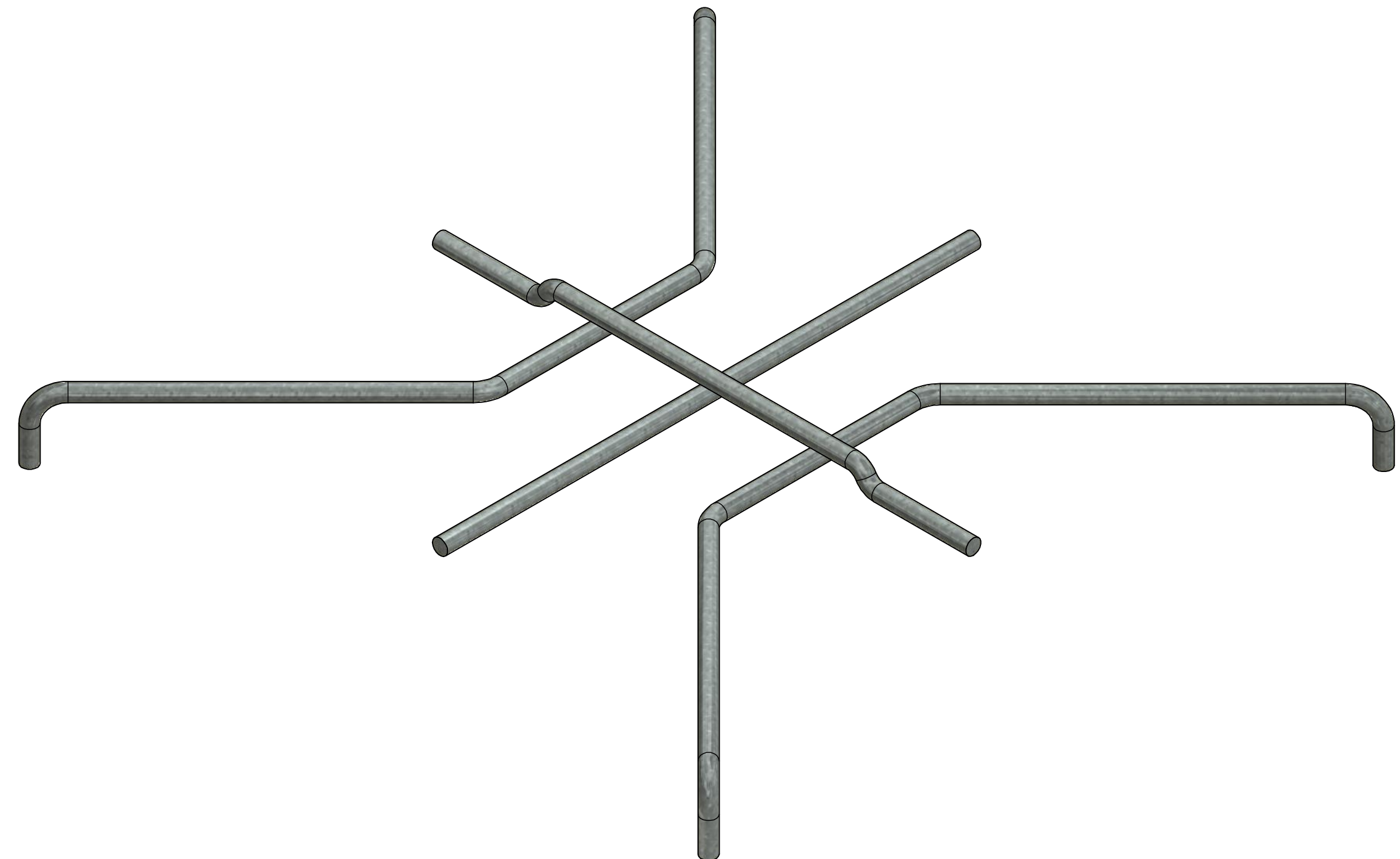

CONFIDENTIAL
 THIS DRAWING IS THE SOLE PROPERTY OF, AND IS PROPRIETARY TO, CABLE MANAGEMENT SOLUTIONS, INC. THIS DRAWING AND/OR INFORMATION SHALL BE KEPT CONFIDENTIAL, AND MAY NOT BE REPRODUCED, MODIFIED, DISCLOSED, OR MADE AVAILABLE TO OTHERS, WITHOUT THE EXPRESS WRITTEN CONSENT OF SNAKETRAY.

PATENTS
 SNAKETRAY, SNAKE CANYON, WALL SNAKE AND LADDER SNAKE PRODUCTS ARE COVERED BY ONE OR MORE OF THE FOLLOWING PATENTS: #6,637,704, #6,637,165, #6,463,704, #6,460,812, #6,449,912, #6,361,000, #6,347,493, #6,019,323, #5,953,870, #5,839,702 AND AUS #737,813.

MATERIAL	GALVANIZED
FINISH	-
TREATMENT	NONE

ALL TOLERANCES IF NOT INDICATED ARE: FRACTIONS= ± 1/32TH .XX= ± .015 .XXX= ± .005 ANGLULAR= ± 1/2 DEGREE	
DRAWN BY	DATE
W. WEST	3/23/2010
CHECKED BY	DATE
E. RENZ	10/14/2011
ENGINEERING	DATE
R. JETTE	10/14/2011

		CABLE MANAGEMENT SOLUTIONS, INC. 291 SKIP LANE BAY SHORE, NY 11706	
TITLE: 101 SERIES INTERSECTION, 6" X 6"			
SIZE	USED ON	DWG NO	
D	101 SERIES	CM 0606	
SCALE	RELEASE DATE	SHEET	REV. NO
NONE		1 OF 1	A